

CB63-100EU
 CB63-200EU
 CB63-300EU
 CB63-400EU
 CB63-500EU

CB100-200EU
 CB100-300EU
 CB100-400EU
 CB100-500EU
 CB100-600EU

CB160-400EU
 CB160-600EU
 CB160-800EU

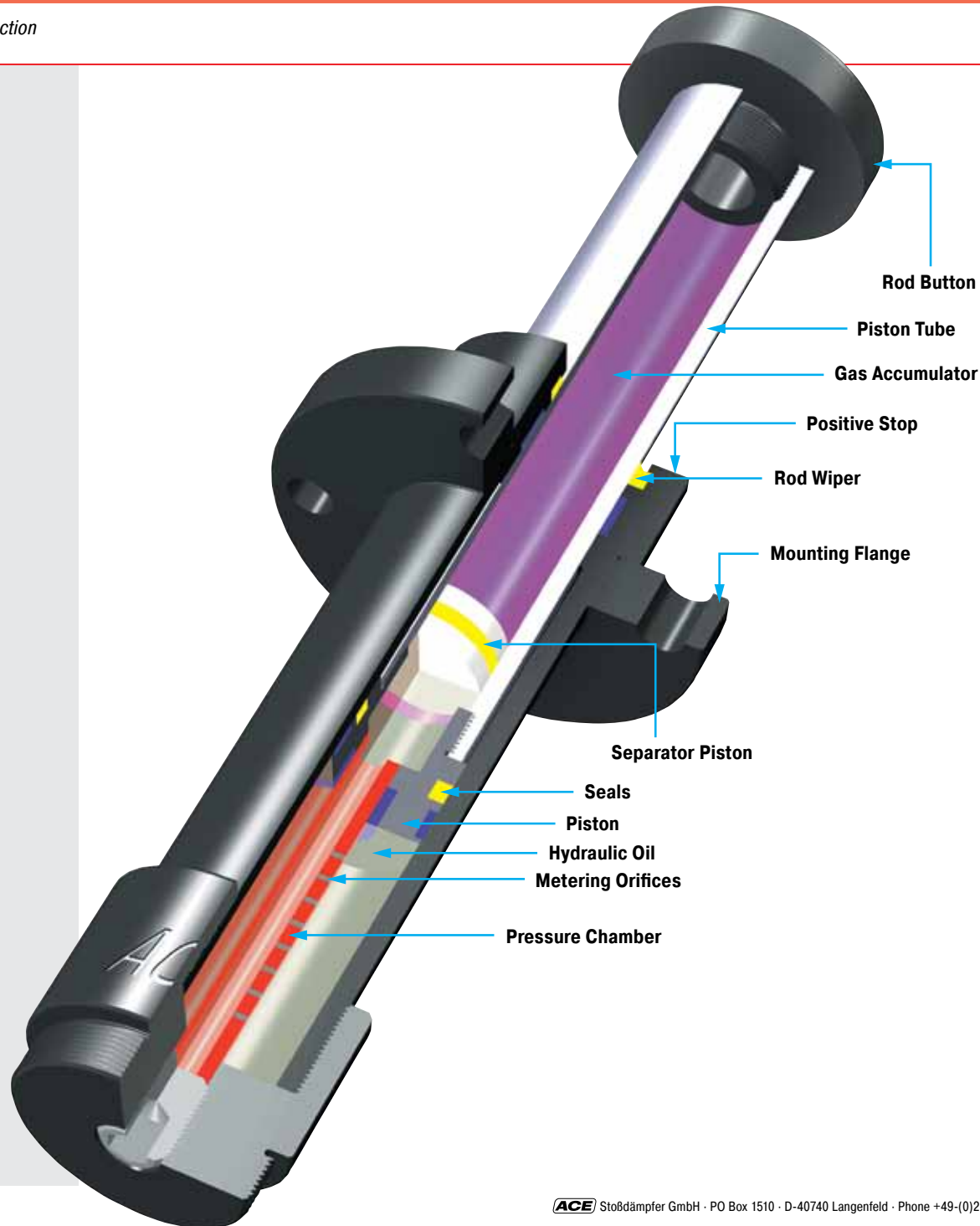

Content	Page
General information	2
Safety information	2
Purpose	2
Description and function	2
Calculation and dimensioning	2
Delivery and storage	2
Maintenance and care	2
Dismantling and disposal	2
Mounting Instructions	3 – 5
Warranty	6
Technical Data	6
EG-Declaration of conformity	7

General information

This operating manual serves the purpose of fault-free use of the safety shock absorber types listed on page 1, compliance is a prerequisite for fulfilment of any warranty claims.

Please read the operating manual before use.

Always comply with the limit values provided in the performance table (technical data).

Please consider the prevailing environmental conditions and stipulations.

Please pay attention to the regulations from the trade association, technical inspection association or the corresponding national, international and European regulations.

Only install and commission in accordance with the assembly instructions.

General Function

F = Force (N)
P = Internal pressure (bar)
s = Stroke (m)
t = Deceleration time (s)
v = Velocity (m/s)

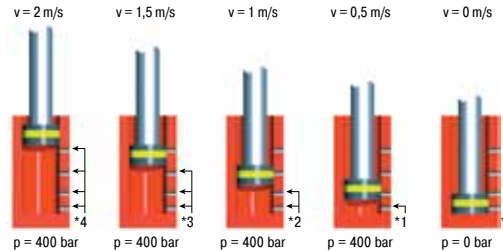
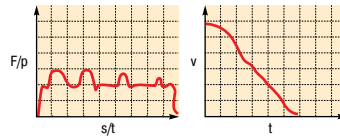

* The load velocity reduces continuously as you travel through the stroke due to the reduction in the number of metering orifices (*) in action. The internal pressure remains essentially constant and thus the Force vs. stroke curve remains linear.

Calculation and dimensioning

In order to guarantee the long life time of the safety shock absorber it must be correctly calculated and dimensioned.

For that the following parameters must be considered:

- > moving mass [kg]
- > impact velocity of moving mass onto the shock absorber [m/s]
- > additional acting propelling force, motor power or propelling torque [N, kW, Nm]
- > number of parallel acting shock absorbers [n]
- > number of strokes or cycles per hour [1/h]

The correct dimensioning of safety shock absorbers can be made with the ACE online calculation program at www.ace-ace.com.

Alternatively the filled out online form may be sent to us via

E-Mail. Or call our free of charge calculation service:

+49-(0)2173-9226-20.

WARNING

- ⚠ The shock absorbers have to be dimensioned in such a way that the calculated values do not exceed the maximum values of the individual capacity chart (see Technical Data):
W₃ [Nm/stroke]
W₄ [Nm/h]
effective weight me
max. side load angle [°]
- ⚠ The calculation and selection of the correct ACE safety shock absorber for your application should be referred to ACE for approval and assignment of a unique identification number.
- ⚠ To correctly calculate the safety shock absorber it must be the only emergency braking system.

Safety information

WARNING

- ⚠ Free moving masses can lead to injuries due to crushing when installing the shock absorber. Protect moving masses against unintentional start-up with suitable safety precautions before installing the shock absorbers.

Purpose

ACE safety shock absorbers are machine elements to brake moving masses in a defined end position in emergency stop situations for axial forces. The safety shock absorbers are not designed for regular operational usage.

Description and function

The ACE safety shock absorbers CB63 to CB160 are maintenance-free, ready-to-install, hydraulic elements with a number of throttle openings.

In the braking process, the moving mass drives the piston rod with kinetic energy, and possibly with additional drive energy, in an axial direction with the defined impact speed against the impact head on the shock absorber. As an alternative, several shock absorbers can be used in parallel. In the braking procedure used, the piston rod is pushed into the shock absorber. The hydraulic oil in front of the piston is forced through all throttle bores at the same time. The number of effective throttle openings reduces proportional to the driven stroke. The moving speed reduces.

The dynamic pressure in front of the piston corresponds with the counterforce applied by the shock absorber and remains almost constant throughout the whole stroke. A prerequisite for a constant deceleration is the correct calculation of the safety shock absorber and therefore the correct selection of the right throttle bore pattern or the correct hardness level of the shock absorber.

Delivery and storage

- > Please check the shock absorber for any damage upon delivery.
- > The shock absorbers can suffer damage if allowed to fall. Please remove the shock absorbers carefully from the packaging.
- > Shock absorbers can generally be stored in any position.
- > Storage in the original packaging is recommended.
- > Always store shock absorbers in a dry place to avoid oxidation.
- > The maximum recommended storage time is three years.

Maintenance and care

Safety shock absorbers are sealed systems and do not need special maintenance. Safety shock absorbers that are not used regularly (i.e. that are intended for emergency stop systems) should be checked within the normal time frame for safety checks, but at least once a year. At this time special attention must be paid to checking that the piston rod resets to its fully extended position, that there is no oil leakage and that the mounting brackets are still secure and undamaged. The piston rod must not show any signs of damage. Safety shock absorbers that are in use regularly should be checked **every three months**.

Dismantling and disposal

Ensure that the shock absorbers are dealt with under consideration of environmental protection (problematic substance utilisation).

The CB63 to CB160 safety shock absorbers are filled with Automatic Transmission Fluid (ATF) oil. You can request the corresponding data sheets for the respective type.

The CB63 to CB160 safety shock absorbers are repairable. Defective absorbers can be sent to our services department to establish the cause of failure.

Mounting instructions

Prior to installation and use, check if the identification number on the shock absorber or on the package corresponds to the number on the delivery sheet. Industrial shock absorbers are maintenance-free and ready-to-fit.

Operating temperature range: -12 °C to 66 °C

Mounting: In any position, but always so that the complete stroke can be used. The shock absorber is to be mounted so that the forces can be guided centrally via the piston rod. The maximum permissible side load may not be exceeded.

Safety shock absorbers may not be transferred from one application place to another if the application characteristics are not identical. Contact ACE if in any doubt.

Emergency stop application: After an emergency impact has occurred, the safety shock absorber must be checked for the proper rod return, the seal tightness and the fastening of mounting elements.

Damage to the piston rod, outer body, or to the mounts should be inspected and considered for replacement or refurbishment.

Regular start up: Safety shock absorbers may be operated with the complete stroke in creep speed at 1/10 of the maximum impact velocity.

Inspection: An inspection should be carried out not less than every **three months**.

WARNING	
	Shock absorbers can break away on impact. The assembly has to be dimensioned in a way that the maximum forces can be absorbed.
	Check the following points after hitting the safety shock absorber in an emergency: complete rod return, seal tightness and screw connection of mounting elements.

Initial Start-Up Checks

First impacts on the shock absorber should only be tried after correctly mounting and with reduced impact speeds and – if possible – with reduced load. Differences between calculated and actual operating data can then be detected early on, and damage to your system can be avoided. If the shock absorbers were selected on calculated data that does not correspond to the maximum possible loading (i.e. selection based on drive power being switched off or at reduced impact speed) then these restricted impact conditions must not be exceeded during initial testing or subsequent use of the system. Otherwise you risk damaging the shock absorbers and/or your machine by overstressing materials. After the initial trial check that the piston rod fully extends again and that there are no signs of oil leakage. Also check that the mounting hardware is still securely tightened. You need to satisfy yourself that no damage has occurred to the piston rod, the body, or the mounting hardware.

Disposal of packaging

Dispose of packaging in an environmentally safe manner. The recycling of packaging saves raw materials and lowers the amount of waste. The used packaging materials do not contain illegal substances.

WARNING	
	Please check that the customer specific inner tube ID number at the end of the shock absorber description and number on the delivery note match exactly. The application data on the safety shock absorbers label, such as moving masses and the max. impact velocity, must be matched with the technical calculation by ACE. This check is important to make sure that the damper is correctly calculated for the application. Otherwise damage to the machine or safety shock absorbers can occur due to overload.
	The gas accumulators on safety shock absorbers from the CB series are filled with nitrogen in the factory. The corresponding filling pressure (5.6 to 5.9 bar) can be taken from the absorber label. The absorbers may only be operated with this filling pressure. A reduced filling pressure can lead to major malfunctions.
	Moving masses can lead to injuries or bodily harm when installing the shock absorber. Secure moving masses against accidental movement.
	The shock absorbers may be unsuitable for the application and show insufficient damping performance. Check for proper suitability of shock absorber.
	When operating outside the allowed temperature range, the shock absorber may lose its function. Permissible temperature range must be adhered to. Do not paint the shock absorber due to heat radiation.
	Ambient fluids, gases and dirt particles may affect or damage the sealing system and lead to failure of the shock absorber. Piston rods and sealing systems must be protected against foreign substances.
	Damage to the piston rod surface may destroy the sealing system. Do not grease, oil, etc. the piston rod and protect it from dirt particles.
	The piston rod can be torn out of the shock absorber. Do not put tensile stress on the piston rod.

Front Flange - F

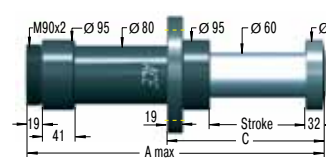

Rear Flange - R

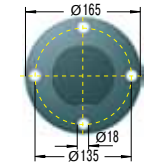
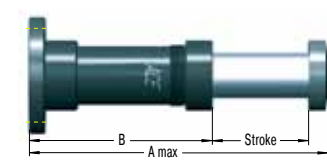

Dimensions

Type	Stroke mm	A max	B	C	Max. Side Load Angle °	Weight kg
CB63-100EU	100	420	288	192	3.5	12.7
CB63-200EU	200	700	468	292	3	16.7
CB63-300EU	300	980	648	392	2.5	20.8
CB63-400EU	400	1260	828	492	2	24.8
CB63-500EU	500	1540	1008	592	1.5	28.8

EU Marking

Starting with the production date September 2010 (Code IB or 10244) all shock absorbers are to be marked with an additional EU letter code in the identification number. The EU marking refers to the adherence to the required norms, laws, and guidelines of the EU. Only products marked with EU ensure the worldwide standard and the guarantee for liability.

Mounting instructions

Prior to installation and use, check if the identification number on the shock absorber or on the package corresponds to the number on the delivery sheet. Industrial shock absorbers are maintenance-free and ready-to-fit.

Operating temperature range: -12 °C to 66 °C

Mounting: In any position, but always so that the complete stroke can be used. The shock absorber is to be mounted so that the forces can be guided centrally via the piston rod. The maximum permissible side load may not be exceeded.

Safety shock absorbers may not be transferred from one application place to another if the application characteristics are not identical. Contact ACE if in any doubt.

Emergency stop application: After an emergency impact has occurred, the safety shock absorber must be checked for the proper rod return, the seal tightness and the fastening of mounting elements.

Damage to the piston rod, outer body, or to the mounts should be inspected and considered for replacement or refurbishment.

Regular start up: Safety shock absorbers may be operated with the complete stroke in creep speed at 1/10 of the maximum impact velocity.

Inspection: An inspection should be carried out not less than every **three months**.

WARNING	
	Shock absorbers can break away on impact. The assembly has to be dimensioned in a way that the maximum forces can be absorbed.
	Check the following points after hitting the safety shock absorber in an emergency: complete rod return, seal tightness and screw connection of mounting elements.

Initial Start-Up Checks

First impacts on the shock absorber should only be tried after correctly mounting and with reduced impact speeds and – if possible – with reduced load. Differences between calculated and actual operating data can then be detected early on, and damage to your system can be avoided. If the shock absorbers were selected on calculated data that does not correspond to the maximum possible loading (i.e. selection based on drive power being switched off or at reduced impact speed) then these restricted impact conditions must not be exceeded during initial testing or subsequent use of the system. Otherwise you risk damaging the shock absorbers and/or your machine by overstressing materials. After the initial trial check that the piston rod fully extends again and that there are no signs of oil leakage. Also check that the mounting hardware is still securely tightened. You need to satisfy yourself that no damage has occurred to the piston rod, the body, or the mounting hardware.

Disposal of packaging

Dispose of packaging in an environmentally safe manner. The recycling of packaging saves raw materials and lowers the amount of waste. The used packaging materials do not contain illegal substances.

WARNING	
	Please check that the customer specific inner tube ID number at the end of the shock absorber description and number on the delivery note match exactly. The application data on the safety shock absorbers label, such as moving masses and the max. impact velocity, must be matched with the technical calculation by ACE. This check is important to make sure that the damper is correctly calculated for the application. Otherwise damage to the machine or safety shock absorbers can occur due to overload.
	The gas accumulators on safety shock absorbers from the CB series are filled with nitrogen in the factory. The corresponding filling pressure (5.6 to 5.9 bar) can be taken from the absorber label. The absorbers may only be operated with this filling pressure. A reduced filling pressure can lead to major malfunctions.
	Moving masses can lead to injuries or bodily harm when installing the shock absorber. Secure moving masses against accidental movement.
	The shock absorbers may be unsuitable for the application and show insufficient damping performance. Check for proper suitability of shock absorber.
	When operating outside the allowed temperature range, the shock absorber may lose its function. Permissible temperature range must be adhered to. Do not paint the shock absorber due to heat radiation.
	Ambient fluids, gases and dirt particles may affect or damage the sealing system and lead to failure of the shock absorber. Piston rods and sealing systems must be protected against foreign substances.
	Damage to the piston rod surface may destroy the sealing system. Do not grease, oil, etc. the piston rod and protect it from dirt particles.
	The piston rod can be torn out of the shock absorber. Do not put tensile stress on the piston rod.

Front Flange - F

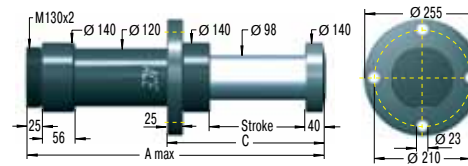

Rear Flange - R

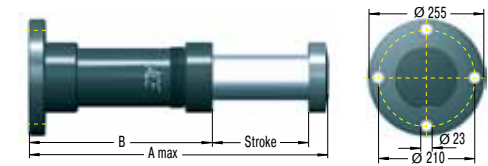

Dimensions

Type	Stroke mm	A max	B	C	Max. Side Load Angle °	Weight kg
CB100-200EU	200	735	495	320	4	58.6
CB100-300EU	300	1005	665	420	3.5	70
CB100-400EU	400	1275	835	520	3	82.5
CB100-500EU	500	1545	1005	620	2.5	67.5
CB100-600EU	600	1815	1175	720	2	75.8

EU Marking

Starting with the production date September 2010 (Code IB or 10244) all shock absorbers are to be marked with an additional EU letter code in the identification number. The EU marking refers to the adherence to the required norms, laws, and guidelines of the EU. Only products marked with EU ensure the worldwide standard and the guarantee for liability.

Mounting instructions

Prior to installation and use, check if the identification number on the shock absorber or on the package corresponds to the number on the delivery sheet. Industrial shock absorbers are maintenance-free and ready-to-fit.

Operating temperature range: -12 °C to 66 °C

Mounting: In any position, but always so that the complete stroke can be used. The shock absorber is to be mounted so that the forces can be guided centrally via the piston rod. The maximum permissible side load may not be exceeded.

Safety shock absorbers may not be transferred from one application place to another if the application characteristics are not identical. Contact ACE if in any doubt.

Emergency stop application: After an emergency impact has occurred, the safety shock absorber must be checked for the proper rod return, the seal tightness and the fastening of mounting elements.

Damage to the piston rod, outer body, or to the mounts should be inspected and considered for replacement or refurbishment.

Regular start up: Safety shock absorbers may be operated with the complete stroke in creep speed at 1/10 of the maximum impact velocity.

Inspection: An inspection should be carried out not less than every **three months**.

WARNING

Shock absorbers can break away on impact. The assembly has to be dimensioned in a way that the maximum forces can be absorbed.

Check the following points after hitting the safety shock absorber in an emergency: complete rod return, seal tightness and screw connection of mounting elements.

Initial Start-Up Checks

First impacts on the shock absorber should only be tried after correctly mounting and with reduced impact speeds and – if possible – with reduced load. Differences between calculated and actual operating data can then be detected early on, and damage to your system can be avoided. If the shock absorbers were selected on calculated data that does not correspond to the maximum possible loading (i.e. selection based on drive power being switched off or at reduced impact speed) then these restricted impact conditions must not be exceeded during initial testing or subsequent use of the system. Otherwise you risk damaging the shock absorbers and/or your machine by overstressing materials. After the initial trial check that the piston rod fully extends again and that there are no signs of oil leakage. Also check that the mounting hardware is still securely tightened. You need to satisfy yourself that no damage has occurred to the piston rod, the body, or the mounting hardware.

Disposal of packaging

Dispose of packaging in an environmentally safe manner. The recycling of packaging saves raw materials and lowers the amount of waste. The used packaging materials do not contain illegal substances.

WARNING

Please check that the customer specific inner tube ID number at the end of the shock absorber description and number on the delivery note match exactly. The application data on the safety shock absorbers label, such as moving masses and the max. impact velocity, must be matched with the technical calculation by ACE. This check is important to make sure that the damper is correctly calculated for the application. Otherwise damage to the machine or safety shock absorbers can occur due to overload.

The gas accumulators on safety shock absorbers from the CB series are filled with nitrogen in the factory. The corresponding filling pressure (5.6 to 5.9 bar) can be taken from the absorber label. The absorbers may only be operated with this filling pressure. A reduced filling pressure can lead to major malfunctions.

Moving masses can lead to injuries or bodily harm when installing the shock absorber. Secure moving masses against accidental movement.

The shock absorbers may be unsuitable for the application and show insufficient damping performance. Check for proper suitability of shock absorber.

When operating outside the allowed temperature range, the shock absorber may lose its function. Permissible temperature range must be adhered to. Do not paint the shock absorber due to heat radiation.

Ambient fluids, gases and dirt particles may affect or damage the sealing system and lead to failure of the shock absorber. Piston rods and sealing systems must be protected against foreign substances.

Damage to the piston rod surface may destroy the sealing system. Do not grease, oil, etc. the piston rod and protect it from dirt particles.

The piston rod can be torn out of the shock absorber. Do not put tensile stress on the piston rod.

Front Flange -F

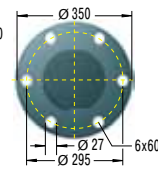
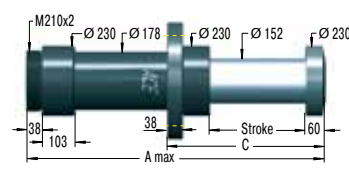

Rear Flange -R

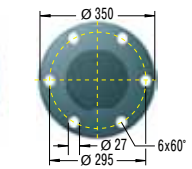
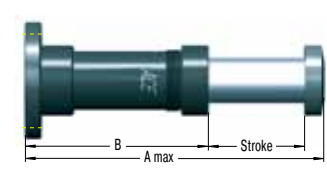

Dimensions						
Type	Stroke mm	A max	B	C	Max. Side Load Angle °	Weight kg
CB160-400EU	400	1400	940	600	4	154.6
CB160-600EU	600	2000	1340	800	3	188
CB160-800EU	800	2600	1740	1000	2	221.3

EU Marking

Starting with the production date September 2010 (Code IB or 10244) all shock absorbers are to be marked with an additional EU letter code in the identification number. The EU marking refers to the adherence to the required norms, laws, and guidelines of the EU. Only products marked with EU ensure the worldwide standard and the guarantee for liability.

Warranty

All changes to the product generally lead to exclusion of warranty.

Obvious defects must be immediately notified in writing to the seller upon delivery, within one week at the latest, but always before processing or installation, otherwise enforcement of a warranty claim is excluded. Punctual despatch is sufficient to comply with the deadline.

The seller must be given the opportunity to check on the premises. In the case of an authorised complaint, the seller can choose between an improvement and replacement delivery. If subsequent fulfilment is not successful, the buyer can choose between reducing the payment (reduction) and reversing the contract (withdrawal). The buyer is not entitled to withdraw from the contract in the case of a negligible contract breach; especially negligible defects.

If the buyer chooses to withdraw from the contract due to a legal or material defect after failed subsequent fulfilment, he is not entitled to additional claims to replacement of damages due to a defect.

If the buyer chooses replacement of damages after failed subsequent fulfilment, the goods remain with the buyer where feasible. Replacement of damages is restricted to the difference between the purchase price and the value of the defective item. This does not apply if the seller has caused a fraudulent breach of the contract.

Only the product description from the seller is generally agreed with respect to the properties of the goods. Public statements, promotions or advertising by the manufacturer do not represent contractual properties of the goods. If the buyer receives a faulty set of assembly instructions, the seller is only obliged to supply a correct set of instructions and only if the fault in the assembly instructions oppose correct assembly.

The warranty period is two years and begins upon completion. The exchange and return of customised production items is generally excluded. The factory conditions in the manufacturing plant, which can be viewed by the ordering party on the seller's premises at any time, apply to parts not produced and processes by the seller. Construction and installation parts are supplied according to the most recent status.

Life expectancy

In general shock absorbers are machine elements that are designed for emergency stop applications.

Safety shock absorbers can be traversed with 1/10 of the maximum impact velocity with 100% stroke usage at creep speed.

The sealing elements are subject to wear and tear when approaching in creep speed. The wear of the seals largely depends on the ambient temperature and the individual application with its parameters. The expected life expectancy is on average about 100,000 strokes.

Capacity Chart

Type	Stroke mm	Max. Energy Capacity W ₃ Nm/Cycle	Effective Weight me		Min. Return Force N	Max. Return Force N	Max. Side Load Angle °	Weight kg
			me min. kg	me max. kg				
CB63-100EU	100	16000	900	128000	1700	18500	3.5	12.7
CB63-200EU	200	32000	1800	256000	1700	24000	3	16.7
CB63-300EU	300	48000	2700	384000	1700	27000	2.5	20.8
CB63-400EU	400	64000	3700	512000	1700	29000	2	24.8
CB63-500EU	500	80000	4700	640000	1700	30000	1.5	28.8
CB100-200EU	200	80000	6900	640000	4500	44000	4	58.6
CB100-300EU	300	120000	10300	960000	4500	56000	3.5	70
CB100-400EU	400	160000	13800	1280000	4500	65000	3	82.5
CB100-500EU	500	200000	17200	1600000	4500	71000	2.5	67.5
CB100-600EU	600	240000	20700	1920000	4500	76000	2	75.8
CB160-400EU	400	240000	22700	1920000	11000	71000	4	154.6
CB160-600EU	600	360000	34000	2880000	11000	71000	3	188
CB160-800EU	800	480000	45400	3840000	11000	71000	2	221.3

¹ The correct effective weight range for your application will be calculated by ACE and should fall within this band.

Technical Data

Impact velocity range: **0,5 m/s to 4,6 m/s**

Rod end button: **Steel hardened with black oxide finish**

Piston Rod Seal: **NBR**

Operating fluid: **Automatic Transmission Fluid (ATF)**

Piston Rod: **Steel hardened and chrome plated**

Shock absorber body: **Steel with black oxide finish**

Operating temperature range: **-12°C to 66°C**

ACE Stoßdämpfer GmbH
Albert-Einstein-Straße 15
D-40764 Langenfeld
Postfach 1510
D-40740 Langenfeld

Tel: +49 - (0)2173 - 9226-10
Fax: +49 - (0)2173 - 9226-19
E-Mail: info@ace-int.eu
Internet: www.ace-ace.de
Steuer-Nr.: 135/5701/0040
UST.-Id-Nr.: DE 121 391 584

Deutsche Bank, BLZ 300700 10
Konto-Nr.: 4073490
IBAN: DE88 3007 0010 0407 3490 00
BIC: DEUTDE33
HRB 44976 Düsseldorf
Geschäftsführer: Jürgen Roland

EC-Declaration of Conformity according to 2006/42/EC, Annex II, No.1 A

Content according to 2006/42/EC, Annex II, No.1 A

ACE Stoßdämpfer GmbH, Albert-Einstein-Straße 15, 40764 Langenfeld
Mr. Dipl.- Ing. (FH) Christian Alscher is authorized to compile the technical file according to Annex VII A.

Address of Christian Alscher:
ACE Stoßdämpfer GmbH
Albert-Einstein-Straße 15
40764 Langenfeld
Germany

We hereby declare that the
[type designation]
fulfils all relevant provisions of Directive 2006/42/EC.

The following harmonized standards (or parts there of) were applied:

- Pressure Equipment Directive 97/23/EG
- Directive 2002/95/EG (RoHS)
- EN 982

Langenfeld, 01.10.2010



Christian Alscher